



## THE INFLUENCE OF CONSTRUCTIVE FACTORS AND WORKING CONDITIONS OF DECANTERS ON WASTEWATER PROCESSING EFFICIENCY

Zârnoianu Daniela, PhD Student,<sup>1</sup> Prof. Simion Popescu, PhD,<sup>2</sup> Marin Radu, PhD<sup>3</sup>

<sup>1</sup> Transilvania University of Brasov, Romania, e-mai: daniela.zarnoianu@yahoo.com

<sup>2</sup> Transilvania University of Brasov, Romania, e-mai: daniela.zarnoianu@yahoo.com

<sup>3</sup> CCMMM Bucharest, Romania, e-mail: office@ccmmm.ro

**Abstract:** The paper presents the results obtained in research focused on wastewater decanting processes in a pilot test rig using 3 constructive variants of decanters: with tangential inlet and free exit, with tangential inlet and a discharge threshold and with deflection plates and a discharge threshold, respectively. Research was conducted for various feed flow rates of the decanters and at different temperatures of the wastewater (100°C, 85-90°C and 75°C). In order to determine filtration efficiency by decanter type and working parameters (feed flow rate and temperature of the water fed to the decanter) the suspension/suspended particle concentrations in clear water were measured (in mg/l) at the inlet and exit of the decanter. Also presented are the variation graphs of decanter efficiency versus their construction and working parameters (feed flow rate and temperature of the water separated in the decanter) followed by conclusions concerning the efficiency of the analysed decanter systems

**Keywords:** sedimentation; tangential inlet and free exit decanter, tangential inlet and discharge threshold, with deflection plate inlet and discharge threshold, suspended particle concentrations, separation efficiency

### 1. INTRODUCTION

Industrial wastewater, also known as “used water” or “residual water” are a by-product of manufacturing and processing, and physically represent polyphasic fluids (mixtures) [1;5]. The fundamental characteristic of polyphasic fluids is that at rest the different phases separate by gravitation, because of their different specific weights [2;3;4]. Gravity separation can occur in both vertical directions. Phases heavier than water separate downwards, which process is known as *sedimentation* or *decanting*. On the other hand, phases lighter than water separate upwards, which process is called *flotation*.

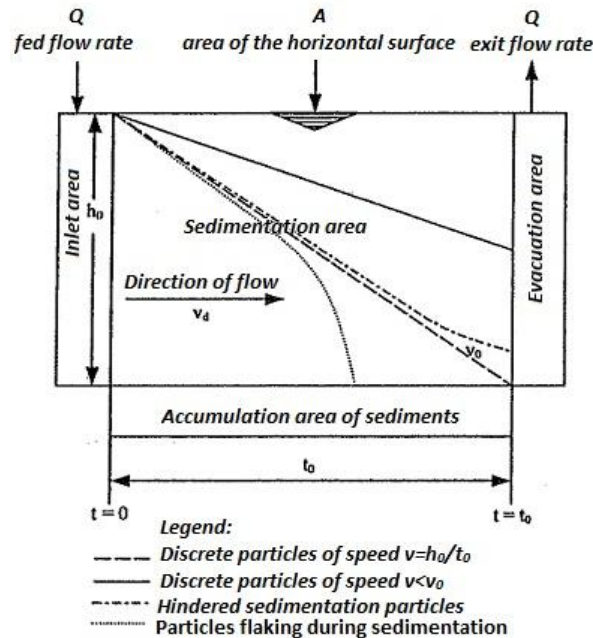
Depending on the type of sediments and their state of dispersion wastewater, the particles, or impurities, have different dimensions. Thus there are discrete granulated particles (sand, gravel), colloidal particles (groups of molecules or substances of 0.5 ... 500 nm size) and molecules or macromolecules in the case of dissolved substances of less than one nanometre in size.

Depending on the type and concentration of the dispersed solid particles as well as on their tendency of agglomeration, the decanting process of the mixtures takes place in four distinctive ways [3]: type I sedimentation, applicable in the case of granulated solid particles; type II sedimentation characteristic for particles tending to agglomerate; type III- mass sedimentation; type IV- compacting or settling.

In the general case several distinctive areas can be identified in a sedimentation basin, conventionally called *decanter* (fig. 1): the inlet area, the sedimentation area, the accumulation area of sediments (sludge area), and the evacuation area of sediments. The mixture containing sediments enters the *inlet area* in turbulent flow and distributes via a uniform, piston or plunger type motion of speed  $v_d$  in the entire cross-section of the basin. Consequently it can be assumed that the concentration of equal size suspended particles is the same in all points of the cross-section located at the end of the inlet area. In the *sedimentation area* the particles settle at the same speed  $v_o$  as the steady, static fluid.

The connection between the distribution and the decanting chamber can be achieved by means of a wall with calibrated holes or by means of a deflector that ensures a steady, laminar flow of the water, free of turbulence (vortices). In reality, however, also secondary convection currents occur caused by the temperature differences

and parasite flows generated by the differences in density of the various areas in the basin. These aspects evidently affect also the separation efficiency of the decanter. The sludge is evacuated swiftly and continuously from the sedimentation area without disturbing the aqueous solution; this is due to the evacuation area meant to ensure the necessary conditions such as to not disturb the flow in the sedimentation area and to collect the whole flow from the entire cross-section of the basin.



**Figure 2.** Schematic defining the parameters of a conventional decanter

The concentration of a mixture (aqueous solution) is the quantity of particles or impurities expressed in mass units over the volume unity of the mixture, and is typically expressed in mg/l [2;4].

The hydraulic balance equation of a decanter is given by on the law of continuity as in equation:

$$Q_i = Q_e + Q_n \quad (1)$$

where  $Q_i$  is the initial flow rate feeding the mixture to the decanter;  $Q_e$  – the flow rate of evacuated aqueous solution and  $Q_n$  – the flow rate of the evacuated sludge (sediment).

The mass balance equation of a decanter is given by the law of mass concentration as in equation :

$$Q_i \cdot C_i = Q_e \cdot C_e + Q_n \cdot C_n \quad (2)$$

where:  $C_i$  is the concentration of the mixture (at the decanter inlet) in mg/l,  $C_e$  - the concentration of the evacuated aqueous solution (at the decanter exit), in mg/l and  $C_n$  – the sludge (sediment) concentration in mg/l.

For an efficiency corresponding to the complete (100%) retention of the particles, the mass balance equation becomes:  $Q_i \cdot C_i = Q_n \cdot C_n$ .

The efficiency of a decanter is assessed by the impurities or particles retention coefficient  $E$  (in percent) defined by the relationship:

$$E = \frac{C_i - C_e}{C_i} \cdot 100 = \left(1 - \frac{C_e}{C_i}\right) \cdot 100 \quad [\%] \quad (3)$$

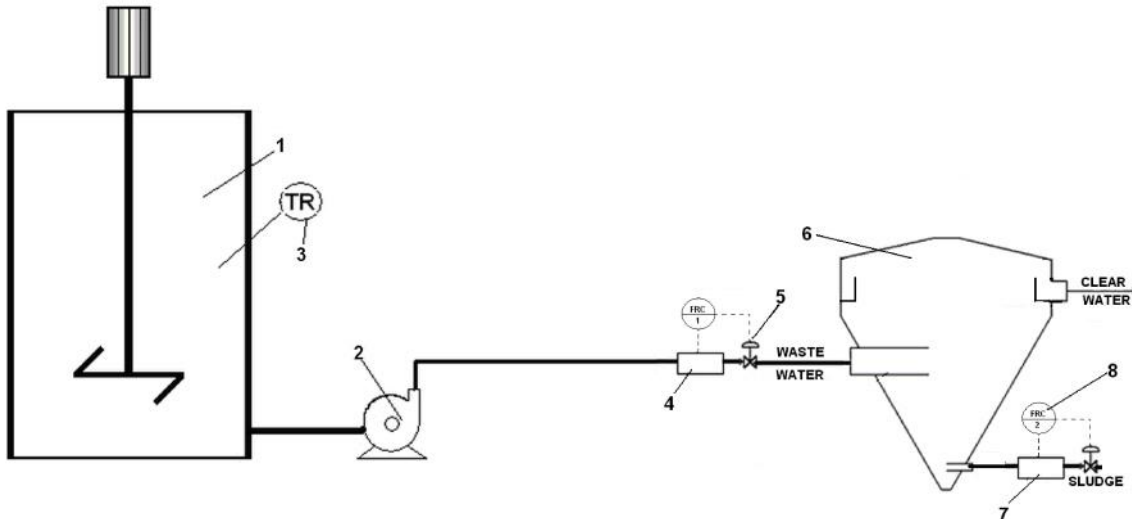
The value of separation coefficient  $E$  depends on the decanter type and the installations it is equipped with and ranges between  $E = 35 \dots 65 \%$

## 2. EXPERIMENTAL RESEARCH

A pilot test rig consisting of decanters similar to the industrial one was developed in order to establish the factors that influence the efficiency of the sedimentation process of industrial wastewater and to identify the optimum constructive variant of a decanter.

The pilot rig (fig. 2) consists of the feeding vessel 1 equipped with an agitator such as to maintain a homogenous composition of the tested water, a centrifugal pump 2 for feeding the decanter 6 in its various constructive variants. The temperature of the wastewater at the decanter inlet is measured with the thermal 3, mounted on vessel 1. The decanter feeding flow rate is measured with the electronic flowmeter 4, mounted on the inlet pipe,

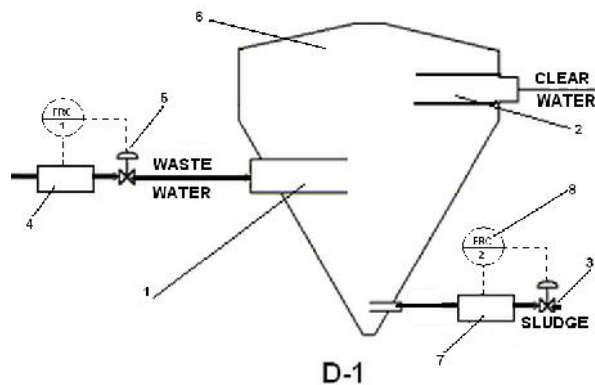
while electronic flowmeter 7 mounted on the sludge exit pipe is used for the sludge evacuation flow rate. The feeding flow rates of the decanter 6 are ensured by the electromagnetic regulator with valves 5 connected to flowmeter 4. The sludge evacuation flow rate is adjusted by the electromagnetic regulator with valves 8 connected to flowmeter 7, with pre-set valve opening and closing times. In accordance with the proposed research plan decantation was experimented for three equipping versions of the pilot decanter, presented in figures 4, 5, and 6.



**Figure 2.** Schematic of the pilot test rigs used in experiments:

1-mixing vessel with agitator; 2- centrifugal pump; 3- thermometer with cu thermal resistor (TR); 4-flowmeter for wastewater feed; 5- wastewater flow rate regulation valve (FRC 1); 6-decanter; 7-sludge evacuation flowmeter, 8- sludge flow rate regulation valve (FRC 2).

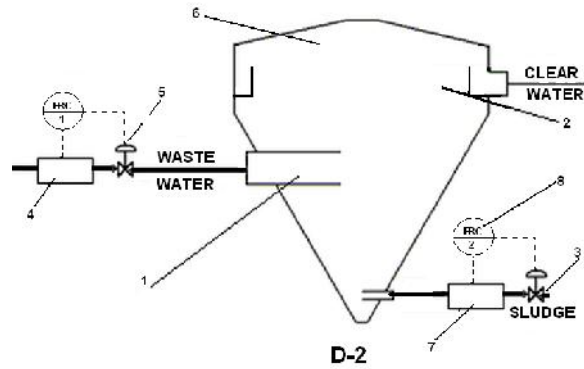
Figure 3 presents the constructive diagram of decanter variant *D1*, where the wastewater inlet is a tangential joint 1, located in the tapered area of the decanter 6. The clear water exits at the upper part of the decanter, in the cylindrical area, are free evacuated through pipe 2 and the sludge is discharged at the bottom of the decanter trough the sludge evacuation 3.



**Figure 3.** Schematic of the decanter with tangential inlet and free exit (*D1*):

1-tangential inlet of wastewater; 2-clear water exit; 3- sludge evacuation; 4-flowmeter for wastewater feed; 5- wastewater flow rate regulation valve (FRC 1); 6-decanter; 7-sludge evacuation flowmeter; 8- sludge flow rate regulation valve (FRC 2)

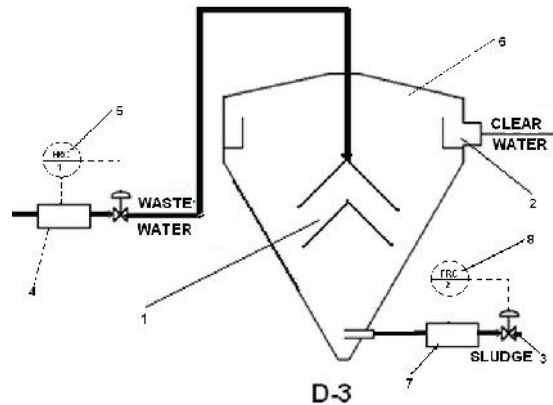
Figure 4 presents the constructive diagram of decanter variant *D2*, where the wastewater inlet is through a tangential joint 1 located in the cylindrical area of the decanter; the clear water exits at the upper, cylindrical part of the decanter by free discharge over threshold 2 and the sludge is discharged at the bottom of the decanter trough the sludge evacuation 3.



**Figure 4.** Schematic of the decanter with tangential inlet and discharge threshold (D2):

1- tangential inlet of wastewater; 2-clear water exit over the discharge threshold; 3-sludge evacuation; 4- flowmeter for wastewater feed; 5- wastewater flow rate regulation valve (FRC 1); 6-decanter; 7-sludge evacuation flowmeter; 8- sludge flow rate regulation valve (FRC 2).

Figure 5 presents the constructive diagram of decanter variant D3 where the wastewater inlet is at the upper part of the decanter via a deflection plate 1; the exit of the clear water is at the upper, cylindrical part of the decanter by free discharge over threshold 2 and the sludge is discharged at the bottom of the decanter trough the sludge evacuation 3.



**Figure 5.** Schematic of the decanter with deflection plate and discharge threshold (D3):

1- deflection plate; 2-clear water exit over discharge threshold; 3-sludge evacuation; 4-flowmeter for wastewater feed; 5- wastewater flow rate regulation valve (FRC 1); 6-decanter; 7-sludge evacuation flowmeter; 8- sludge flow rate regulation valve (FRC 2).

**Table 2.** Results of the experimental determinations on the three types of decanters (D1, D2, D3)

Experimental operation parameters			Decanter type								
			D-1 Tangential inlet and free exit			D-2 Tangential inlet and discharge threshold exit			D-3 With deflection plate and discharge threshold exit		
$T_i$	$Q_i$	$Q_{sludge}$	$C_i$	$C_e$	$E$	$C_i$	$C_e$	$E$	$C_i$	$C_e$	$E$
$^{\circ}\text{C}$	$\text{m}^3/\text{h}$	$\text{m}^3/\text{h}$	$\text{mg}/\text{l}$	$\text{mg}/\text{l}$	%	$\text{mg}/\text{l}$	$\text{mg}/\text{l}$	%	$\text{mg}/\text{l}$	$\text{mg}/\text{l}$	%
100	3	0.34	5898	572.4	90.3	9240	629.8	93.2	10641	95.8	99.1
	4	0.59	6355.5	1047.5	83.5	16040	1300.4	91.8	9115	334.4	96.3
	6	0.89	12710	2056	83.8	9300	1287	86.2	10636.7	853.1	92
	8	1.2	8321	2746	67	11527	2536	78	12170	945	92.2
85-90	3	0.37	5188	640.3	87.7	11950	997.5	91.7	9608	201.8	97.9
	4	0.54	4180	827.4	80.2	15585	1385	91.1	9548.5	354.6	96.3
	6	0.87	4140	1038.2	74.9	10595	1854	82.5	10603	654.6	93.8
	8	1.2	4503	1846	59	12710	4194	67	8671	2130.5	75.4
75	3	0.44	7921	304.9	96.2	13610	1111	91.8	12899	568.8	95.6
	4	0.55	8688	2330.4	73.2	14730	1312.6	91.1	8424	523.5	93.8
	6	0.82	9337	7618	18.4	14170	7283	48.6	11680	1454.4	87.5
	8	1.2	8649	8649	0	14170	10769	24	8470	2406	71.6

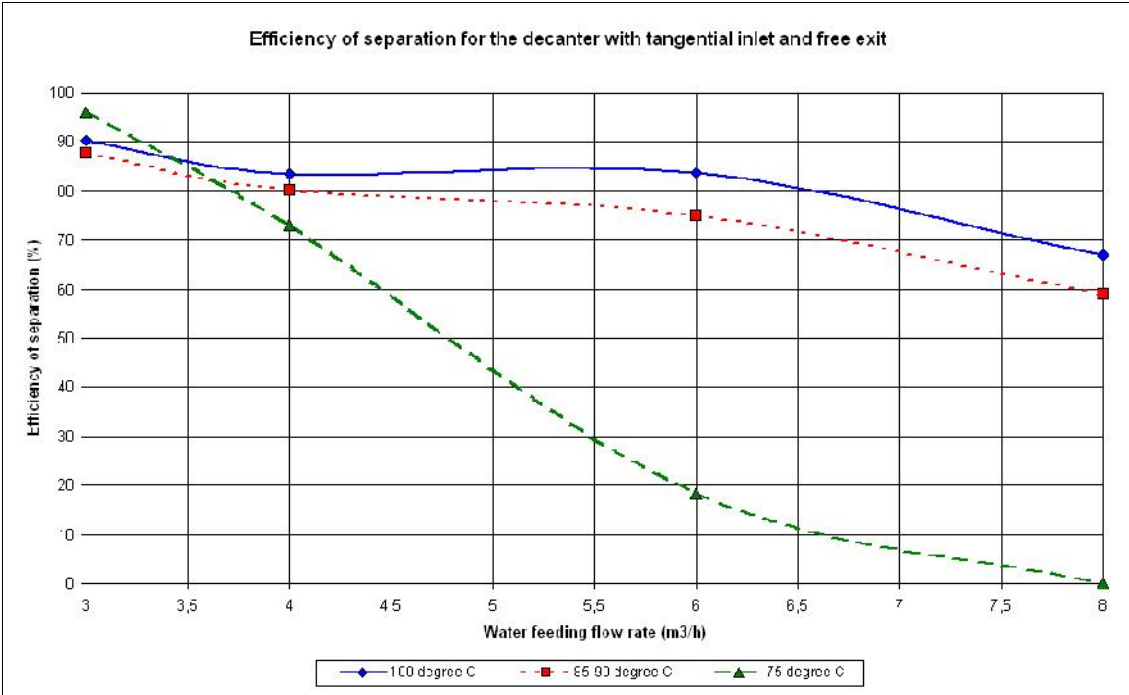
Upon filling vessel 1 (see fig.2) with wastewater subjected to experimenting the pump is turned on thus feeding the decanter. Until the decanter is filled the sludge is periodically purged such as to avoid the clogging of the evacuation system. Once the decanter is filled the automatic sludge evacuation system is started; after 30 minutes of operation the system is considered stable and samples are collected, namely wastewater from the feeding vessel and clear water from the decanter exit. Each decanter model used for testing (see fig. 4, 5, 6) was operated at three distinctive temperatures (100°C, 85-90°C and 75°C) and also at four distinctive values of the wastewater feeding flow rate (3m<sup>3</sup>/h, 4m<sup>3</sup>/h, 5m<sup>3</sup>/h and 8m<sup>3</sup>/h, respectively). For each sample the percentage concentrations of impurities (particles) were determined in mg/l, namely  $C_1$  at the wastewater inlet to the decanter, and  $C_2$  of the clear water exit from the decanter, as well as the separation efficiency in percent, calculated by equation (3). Table 2 shows the results obtained by determinations.

### 3. ANALYSIS OF THE EXPERIMENTAL RESULTS

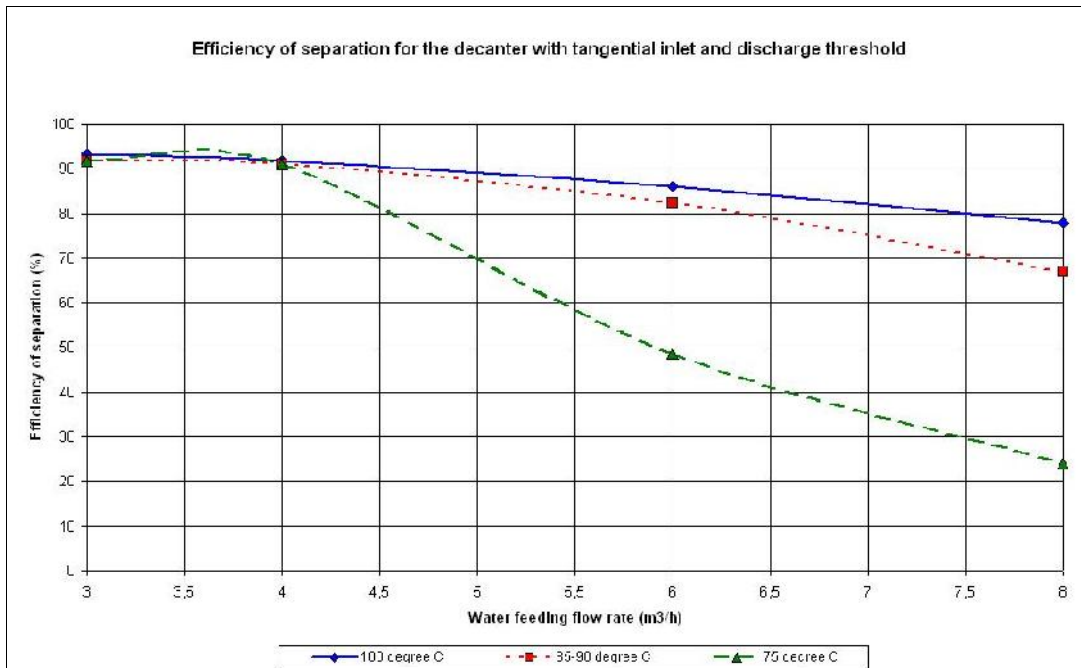
Based on the experimental data in table 1 the variation graphs of efficiency coefficients E versus wastewater feeding flow rate were plotted for various temperatures of the mixture introduced into the decanter feeding vessel. These allow the analysis of the separation process for each decanter type and of the efficiency of separation of the three discussed decanter types at various working temperatures and feeding flow rates.

The graphs in figures 6, 7 and 8 show the variation of the separation efficiency versus feeding flow rate at various water temperatures for the 3 decanter variants.

The analysis of the graph in figure 6 shows that the separation efficiency for the decanter with tangential inlet and free exit *DI* (see fig. 3) decreases with the increase in wastewater feeding flow rate and the lowering of the wastewater temperatures entering the decanter.

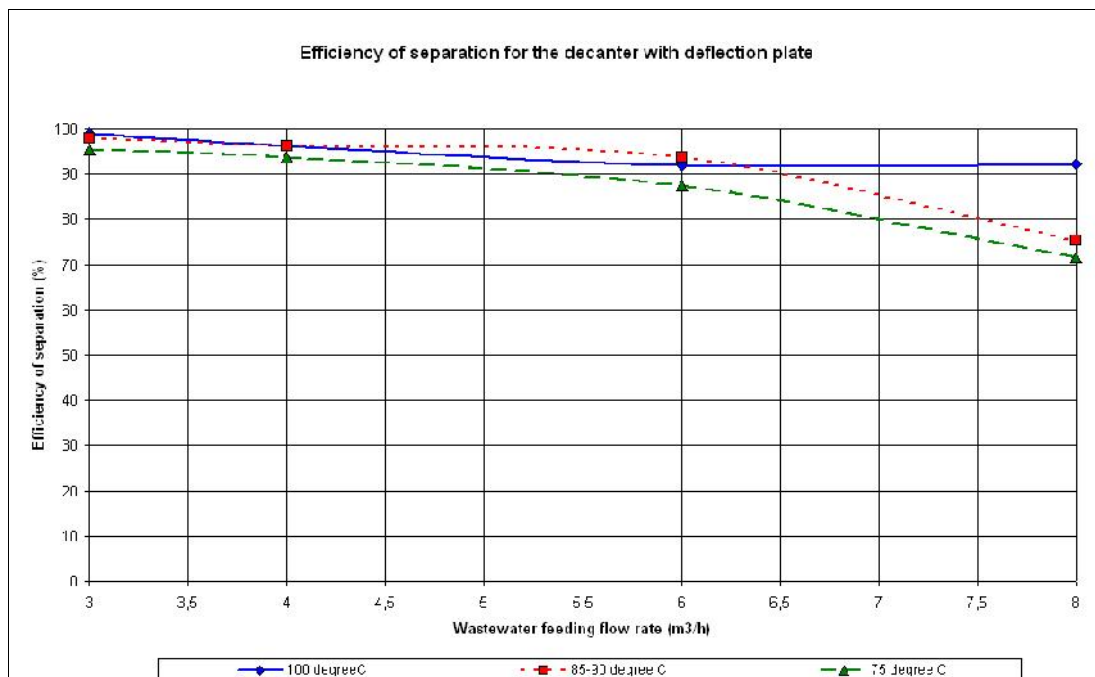


**Figure 6.** Evolution of the separation efficiency versus feeding flow rate for the decanter *DI* with tangential inlet and free exit (see fig. 3) at different wastewater temperatures



**Figure 7.** Evolution of the separation efficiency versus feeding flow rate for the decanter *D2* with tangential inlet and discharge threshold (see fig. 4) at different wastewater temperatures

The analysis of the graph in fig. 7 shows that the separation efficiency for the decanter with tangential inlet and discharge threshold *D2* (see fig. 4), decreases with the increase in feeding flow rate and the lowering of the wastewater temperatures entering the decanter.



**Figure 8.** Evolution of the separation efficiency versus feeding flow rate for the decanter *D3* with deflection plate (see fig.5), at different temperatures of the wastewater

The analysis of figure 8 shows that the separation efficiency of a decanter with deflection plate *D3* (see fig. 5) decreases with the increase of the wastewater feeding flow rate and with the lowering of the wastewater temperatures entering the decanter.

Figure 9, 10 and 11 present, comparatively for the 3 decanter types (*D1*, *D2* and *D3*), the variation graphs of the separation efficiency versus feeding flow rate of the decanters for different wastewater temperatures.

In the graph of figure 9 it can be observed that at a temperature of 100°C a slight decrease of the separation efficiency with the increase of the decanter feeding flow rate occurs regardless of decanter type, and that the decanter with deflection plate presenting the best sedimentation efficiency.

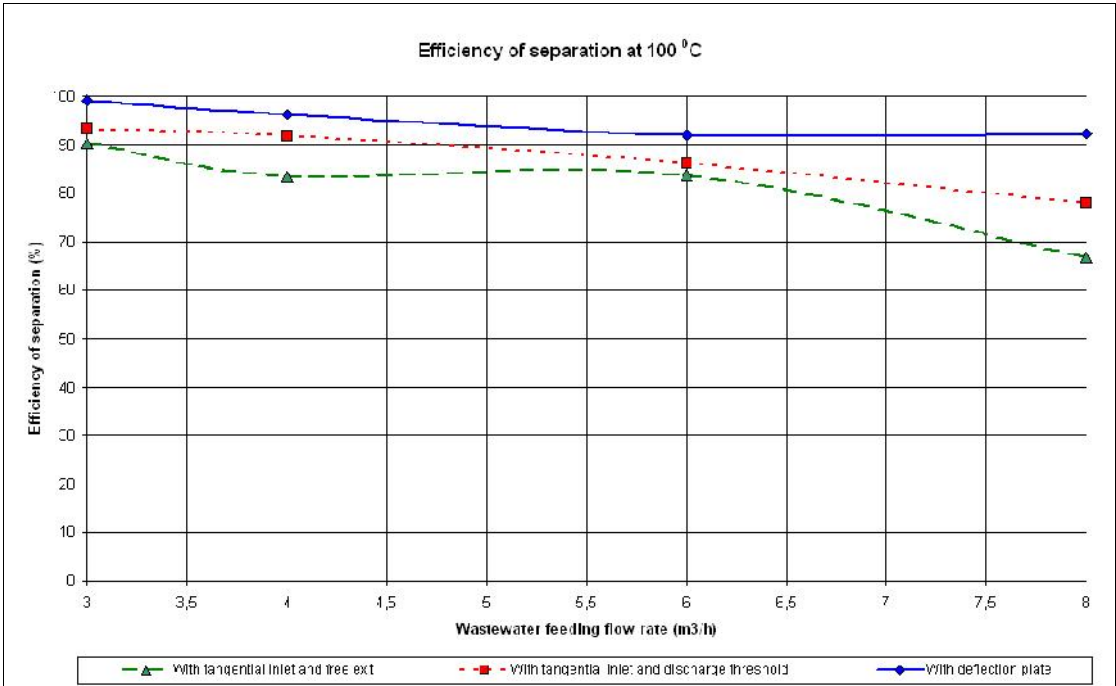


Figure 9. Evolution of the separation efficiency versus flow rate at 100°C, for various types of decanters

In the graph of figure 10 it can be seen that at medium temperatures (85-90°C) the separation efficiency decreases visibly with increasing decanter feeding flow rate, regardless of its type, the best sedimentation efficiency being that of the decanter with deflection plate.

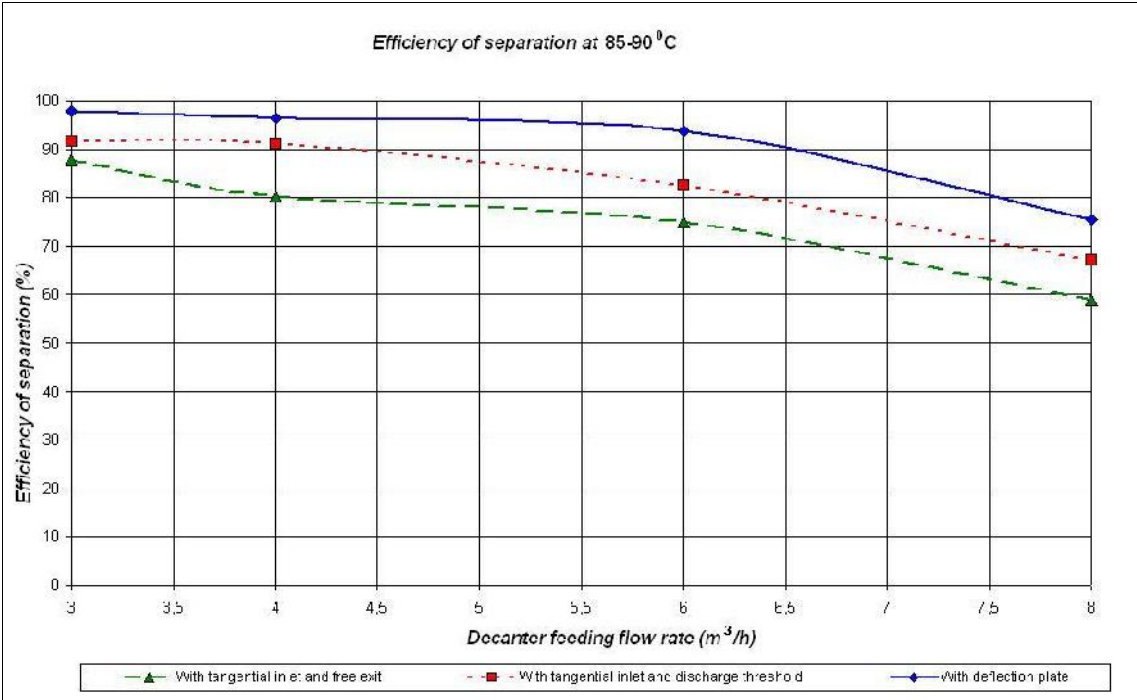
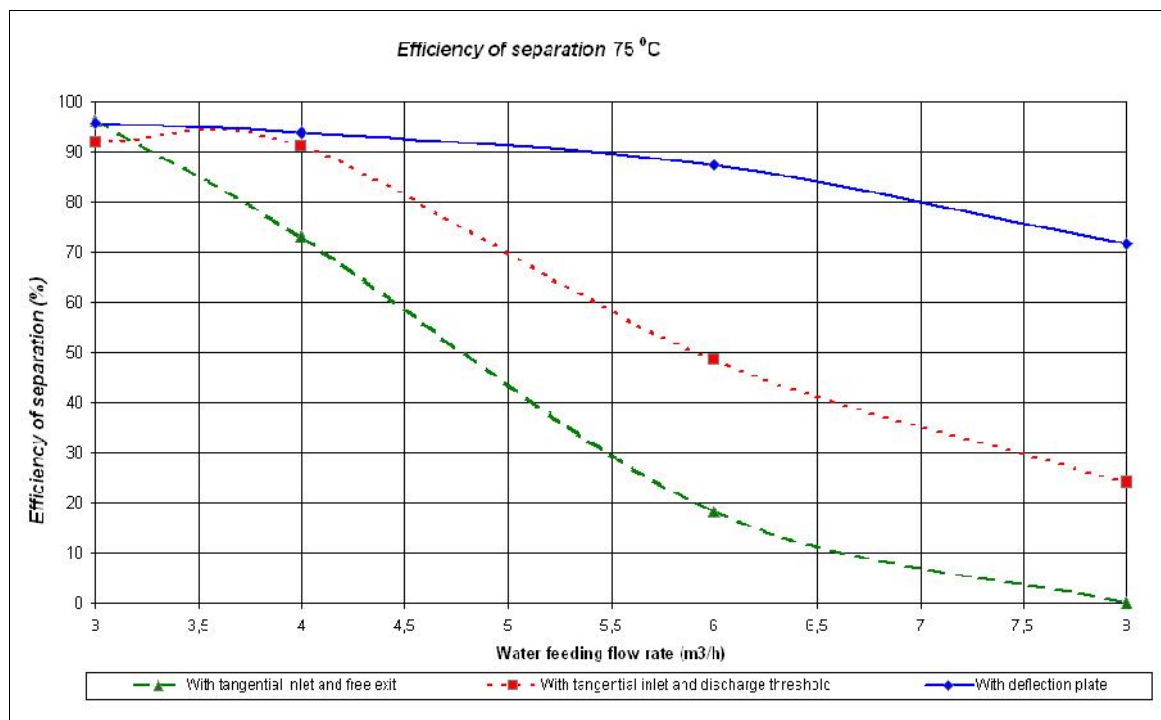


Figure 10. Evolution of the separation efficiency versus flow rate at 85-90°C, for various types of decanters

In the graph of figure 11 it can be seen that at a lower temperature ( $75^{\circ}\text{C}$ ) a significant decrease of the separation efficiency occurs with increasing decanter feeding flow rate, regardless of its type, the best sedimentation efficiency being that of the decanter with deflection plate.



**Figure 11.** Evolution of the separation efficiency versus flow rate at  $75^{\circ}\text{C}$ , for various types of decanters

#### 4. CONCLUSIONS

- The efficiency of separating particles suspended in wastewater by means of decanters is sensibly reduced with a decrease in wastewater temperature in the decanters, the influence of this parameter on separation efficiency being greater at lower temperatures ( $75^{\circ}\text{C}$ ); in this case the best sedimentation efficiency is presented by the decanter with deflector plate.
- The separation of the suspended particles by means of decanting wastewater is the more efficient the higher the inlet temperature and the smaller the feeding flow rate into the decanter are. Regardless of the flow rate magnitude and the temperature of the decanted water, the best efficiency is that of the decanter with deflection plate.

#### REFERENCES

- [1]. Beychok, Milton R. Wastewater treatment. *Hydrocarbon Processing*, December 1971), pp. 109–112
- [2]. Bratu, E.A., Opera ii unitare în ingineria chimic , vol. I, vol. II, Editura Tehnic , Bucuresti, 1984, 1985.
- [3]. Robescu, Diana et al. Tehnici de epurare a apelor uzate, Editura Tehnica, Bucuresti, 2011
- [4]. Rus F. Operații de separare în industria alimentară . Editura Universit ții Transilvania, Brașov, 2001
- [5]. Techobanoglous, G., Burton, F.L., and Stensel, H.D. Wastewater Engineering. (4th Edition ed.). McGraw-Hill Book Company, 2003.

**ACKNOWLEDGEMENT:** This paper is supported by the Sectoral Operational Programme Human Resources Development (SOP HRD), ID134378, financed from the European Social Fund and by the Romanian Government